

CELO

**Quick-fix anchor
assortment**





**The right quick-fix
anchor for every
application!**

BAZ plus 4

BAZ 7

BAZ-H 11

BA plus 13

BA A4 16



Quick-fix anchors	BAZ plus		BAZ				BAZ-H	BA plus		BA A4	
Coating / Material	galvanized	stainless steel A4	galvanized	hot-dip galvanized	stainless steel A4	high corrosion resistant stainless steel HCR	galvanized	galvanized	galvanized	stainless steel A4	
Assortment	M8 - M16		M8 - M16				M8 - M10	M10 - M16	M6 - M20	M10 - M16	M8 - M16
	Option 1 		Option 1 				Option 1 	Option 7 		Option 7 	
 see assessment	✓		✓				✓	✗		✗	
	✓ C1, C2 C2: M10-M16		✓ C1 M8-M16				✗	✗		✗	
	✓		✓				✗	✗		✗	
	✗	✓	✗	✗	✓	✓	✗	✗	✗	✓	
Suitable for outdoor applications	✗	✓	✗	✓ without ETA	✓	✓	✗	✗	✗	✓	
Setting depth marking	✓		✗				✗	✓		✗	
Performance											
 Length marking on the head	✓		✗				✗	✗		✗	
Two setting depths	✓ M10 & M12		✗				✗	✗		✗	
 With big washer for woodworking	✗		✗				✓	✗	✓	✗	
 Available as blister or single label	✗	✓	✓	✗	✓	✗	✗	✓	✓	✗	
Page	4		7				11	13		16	

Quick-fix anchor BAZ plus



Advantages

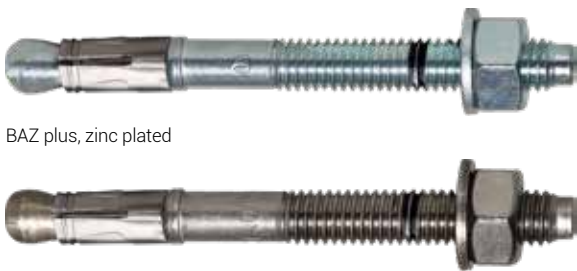



BAZ plus, zinc plated

BAZ plus A4, stainless steel A4

Suitable building materials

Very suitable



- Cracked concrete 
- Non-cracked concrete 

Approvals and certificates

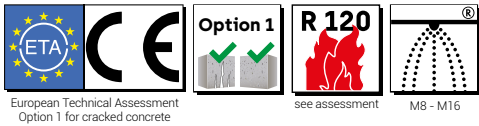

European Technical Assessment
Option 1 for cracked concrete

see assessment

M8 - M16



Mounting

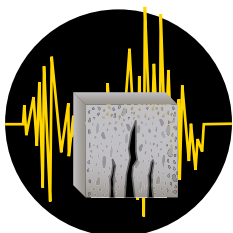
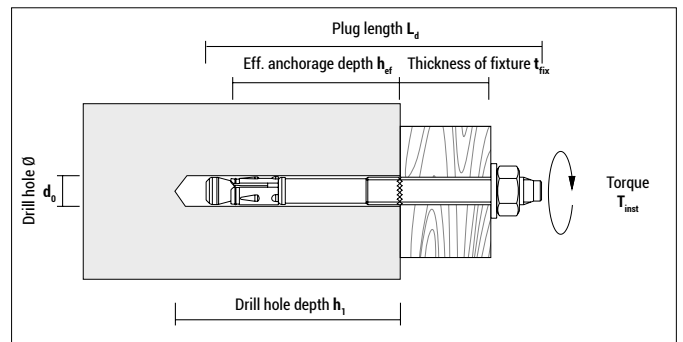
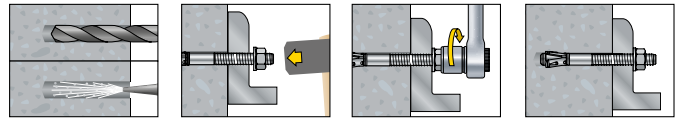

Outstanding performance
in cracked concrete and
for use under seismic
action (C1 and C2)



**Very small edge and
axial distances**
perfect for difficult
installation situations

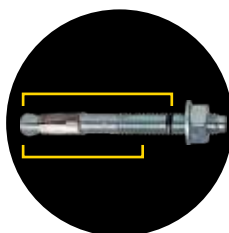

**M10 und M12: Two
setting depths**
for higher appli-
cation flexibility





**Setting depth
marking ring** for
easy and quick
installation



Length marking
on top of the
BAZ plus





BAZ plus, zinc plated

Type	Art-No	d ₀ [mm]	h ₁ ≥ [mm]	h _{ef} ≥ [mm]	L _d [mm]	t _{fix} ≤ [mm]	Thread		 [pcs]	 [pcs]
8-75/10	9875BAZP	8	60	48	75	10	M8	●	50	250
8-95/30	9895BAZP	8	60	48	95	30	M8	●	50	250
8-115/50	98115BAZP	8	60	48	115	50	M8	●	40	200
8-150/85	98150BAZP	8	60	48	150	85	M8	●	40	200
10-72/10	91072BAZP	10	55	40	72	10	M10	●	40	200
10-92/10	91092BAZP	10	55 / 75	40 / 60	92	30 / 10	M10	●	40	200
10-102/20	910102BAZP	10	55 / 75	40 / 60	102	40 / 20	M10	●	25	125
10-112/30	910112BAZP	10	55 / 75	40 / 60	112	50 / 30	M10	●	25	125
10-132/50	910132BAZP	10	55 / 75	40 / 60	132	70 / 50	M10	●	25	125
10-162/80	910162BAZP	10	55 / 75	40 / 60	162	100 / 80	M10	●	25	125
12-88/10	91288BAZP	12	70	50	88	10	M12	●	20	100
12-103/5	912103BAZP	12	70 / 90	50 / 70	103	25 / 5	M12	●	20	100
12-118/20	912118BAZP	12	70 / 90	50 / 70	118	40 / 20	M12	●	20	100
12-128/30	912128BAZP	12	70 / 90	50 / 70	128	50 / 30	M12	●	20	100
12-148/50	912148BAZP	12	70 / 90	50 / 70	148	70 / 50	M12	●	20	100
12-163/65	912163BAZP	12	70 / 90	50 / 70	163	85 / 65	M12	●	20	100
12-178/80	912178BAZP	12	70 / 90	50 / 70	178	100 / 80	M12	●	20	100
16-123/5	916123BAZP	16	110	85	123	5	M16	●	10	50
16-138/20	916138BAZP	16	110	85	138	20	M16	●	10	50
16-168/50	916168BAZP	16	110	85	168	50	M16	●	10	50
16-178/60	916178BAZP	16	110	85	178	60	M16	●	10	50



BAZ plus A4, stainless steel A4



Type	Art-No	d ₀ [mm]	h ₁ ≥ [mm]	h _{ef} ≥ [mm]	L _d [mm]	t _{fix} ≤ [mm]	Thread		 [pcs]	 [pcs]
8-75/10 A4	9X875BAZP	8	60	48	75	10	M8	●	50	250
8-95/30 A4	9X895BAZP	8	60	48	95	30	M8	●	50	250
8-115/50 A4	9X8115BAZP	8	60	48	115	50	M8	●	40	200
8-150/85 A4	9X8150BAZP	8	60	48	150	85	M8	●	40	200
10-72/10 A4	9X1072BAZP	10	55	40	72	10	M10	●	40	200
10-92/10 A4	9X1092BAZP	10	55 / 75	40 / 60	92	30 / 10	M10	●	40	200
10-102/20 A4	9X10102BAZP	10	55 / 75	40 / 60	102	40 / 20	M10	●	25	125
10-112/30 A4	9X10112BAZP	10	55 / 75	40 / 60	112	50 / 30	M10	●	25	125
10-132/50 A4	9X10132BAZP	10	55 / 75	40 / 60	132	70 / 50	M10	●	25	125
10-162/80 A4	9X10162BAZP	10	55 / 75	40 / 60	162	100 / 80	M10	●	25	125
12-88/10 A4	9X1288BAZP	12	70	50	88	10	M12	●	20	100
12-103/5 A4	9X12103BAZP	12	70 / 90	50 / 70	103	25 / 5	M12	●	20	100
12-118/20 A4	9X12118BAZP	12	70 / 90	50 / 70	118	40 / 20	M12	●	20	100
12-128/30 A4	9X12128BAZP	12	70 / 90	50 / 70	128	50 / 30	M12	●	20	100
12-148/50 A4	9X12148BAZP	12	70 / 90	50 / 70	148	70 / 50	M12	●	20	100
12-163/65 A4	9X12163BAZP	12	70 / 90	50 / 70	163	85 / 65	M12	●	20	100
12-178/80 A4	9X12178BAZP	12	70 / 90	50 / 70	178	100 / 80	M12	●	20	100
16-123/5 A4	9X16123BAZP	16	110	85	123	5	M16	●	10	50
16-138/20 A4	9X16138BAZP	16	110	85	138	20	M16	●	10	50
16-168/50 A4	9X16168BAZP	16	110	85	168	50	M16	●	10	50
16-178/60 A4	9X16178BAZP	16	110	85	178	60	M16	●	10	50

Installation parameters

BAZ plus Size		M8		M10		M12		M16	
BAZ plus Type		BAZ plus zinc plated	BAZ plus stainless steel A4	BAZ plus zinc plated	BAZ plus stainless steel A4	BAZ plus zinc plated	BAZ plus stainless steel A4	BAZ plus zinc plated	BAZ plus stainless steel A4
Torque	T_{inst} [Nm]	15	20	30	45	60		110	
Width across flats	SW [mm]	13		17		19		24	
Ø of clearance hole in fixture	d_f [mm]	9		12		14		18	
Washer outer Ø x thickness	[mm]	17 x 1,6		21 x 2,0		24 x 2,5		30 x 3,0	

Spacing and edge distance

BAZ plus Size		M8	M10	M12	M16		
Effective anchorage depth	h_{ef} [mm]	48	40	60	50	70	85
Minimum edge distance	C_{min} [mm]	40	50	50	60	55	65
	for $S \geq$ [mm]	55	190	100	215	110	150
Minimum spacing	S_{min} [mm]	35	50	40	55	60	65
	for $C \geq$ [mm]	50	95	60	110	70	95
Characteristic edge distance	C_{cr} [mm]	72	60	90	75	105	127
Characteristic spacing	S_{cr} [mm]	144	120	180	150	210	254
Min. thickness of structural part	h_{min} [mm]	100	100	120	100	140	170
Reduced min. thickness of structural part ¹⁾	$h_{min-red}$ [mm]	80	–	100	–	–	–

If underrun the char. spacing or edge distance (C_{cr} or S_{cr}) the loads must be reduced. h_{min} , S_{min} and C_{min} must be observed.

¹⁾ Reduced min. thickness of structural part only in non-cracked concrete.

Permissible loads

BAZ plus Size		M8	M10	M12	M16		
Effective anchorage depth	h_{ef} [mm]	48	40	60	50	70	85
Permissible tension load^{1), 2)} for single anchor without influence of spacing and edge distance in cracked concrete C20/25³⁾							
BAZ plus zinc plated	N_{per} [kN]	4,0	4,1	5,7	5,8	7,6	11,4
BAZ plus stainless steel A4	N_{per} [kN]	4,0	4,1	5,7	5,8	7,6	11,4
Permissible tension load^{1), 2)} for single anchor without influence of spacing and edge distance in non-cracked concrete C20/25³⁾							
BAZ plus zinc plated	N_{per} [kN]	5,2	5,7	9,0	8,3	11,9	17,1
BAZ plus stainless steel A4	N_{per} [kN]	5,2	5,7	9,0	8,3	11,9	17,1
Permissible shear load^{1), 2)} for single anchor without influence of spacing and edge distance in cracked concrete C20/25³⁾							
BAZ plus zinc plated	V_{per} [kN]	7,2	11,7	11,7	17,1	17,1	30,9
BAZ plus stainless steel A4	V_{per} [kN]	9,0	11,7	11,7	17,2	19,7	36,4
Permissible shear load^{1), 2)} for single anchor without influence of spacing and edge distance in non-cracked concrete C20/25³⁾							
BAZ plus zinc plated	V_{per} [kN]	7,2	11,7	11,7	17,1	17,1	30,9
BAZ plus stainless steel A4	V_{per} [kN]	9,0	11,7	11,7	19,7	19,7	39,2
Permissible bending moment^{1), 2)}							
BAZ plus zinc plated	M_{per} [Nm]	15,0	29,1	–	51,4	–	125,6
BAZ plus stainless steel A4	M_{per} [Nm]	14,3	29,1	–	51,4	–	122,7

¹⁾ For further information please refer to the ETA assessment

²⁾ Load figures include the resistances' partial safety factors as per ETA assessments and a partial safety factor on the action of $\gamma_F = 1,4$.

Load figures apply for a rebar spacing $S \geq 15$ cm or alternatively for a rebar spacing $S \geq 10$ cm in combination with a rebar diameter of $d_s \leq 10$ mm.

³⁾ For higher concrete strengths up to C50/60 the values increase by max. 58%.

Quick-fix anchor BAZ



Vorteile



BAZ, zinc plated



BAZ A4, stainless steel A4



BAZ HD, hot-dip galvanized





BAZ HCR, stainless steel, high corrosion resistant

Suitable building materials

Very suitable



- Cracked concrete 
- Non-cracked concrete 

Suitable to a limited extent

- Dense natural stone (up to M8)

Approvals and certificates

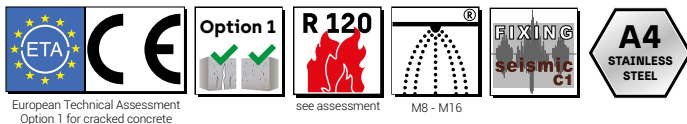

Mounting

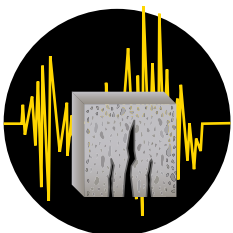
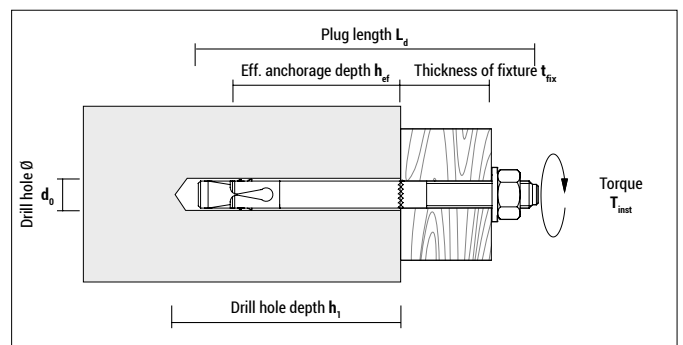
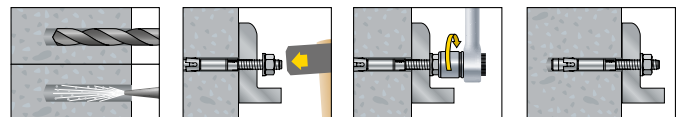

Very high performance in cracked concrete and suitable for use under seismic action [C1]



High load values even with small edge and axial distances



Large assortment in several materials



Available as blister for your individual projects

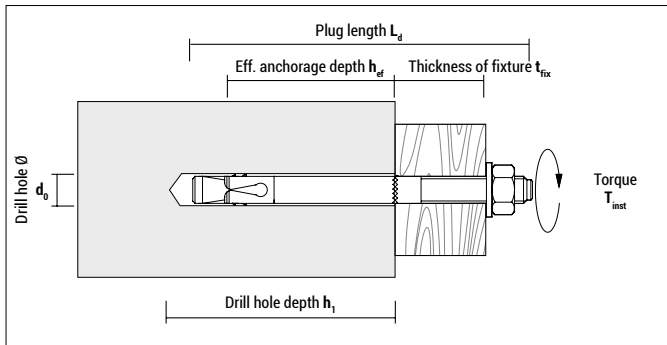

BAZ, zinc plated

Type	Art-No	d ₀ [mm]	h ₁ ≥ [mm]	h _{ef} ≥ [mm]	L _d [mm]	t _{fix} ≤ [mm]	Thread		 [pcs]	 [pcs]
6-40/2	9640BAZ	6	35	25	40	2	M6	—	150	750
6-65/15	9665BAZ	6	45	35	65	15	M6	—	100	500
8-52/2	9852BAZ	8	45	30	52	2	M8	—	100	500
8-72/10	9872BAZ	8	60	45	72	10	M8	●	50	250
8-92/30	9892BAZ	8	60	45	92	30	M8	●	50	250
8-112/50	98112BAZ	8	60	45	112	50	M8	●	40	200
8-147/85	98147BAZ	8	60	45	147	85	M8	●	40	200
10-92/10	91092BAZ	10	75	60	92	10	M10	●	40	200
10-102/20	910102BAZ	10	75	60	102	20	M10	●	25	125
10-112/30	910112BAZ	10	75	60	112	30	M10	●	25	125
10-132/50	910132BAZ	10	75	60	132	50	M10	●	25	125
10-162/80	910162BAZ	10	75	60	162	80	M10	●	25	125
12-103/5	912103BAZ	12	90	70	103	5	M12	●	20	100
12-118/20	912118BAZ	12	90	70	118	20	M12	●	20	100
12-128/30	912128BAZ	12	90	70	128	30	M12	●	20	100
12-148/50	912148BAZ	12	90	70	148	50	M12	●	20	100
12-163/65	912163BAZ	12	90	70	163	65	M12	●	20	100
12-178/80	912178BAZ	12	90	70	178	80	M12	●	20	100
16-123/5	916123BAZ	16	110	85	123	5	M16	●	10	50
16-138/20	916138BAZ	16	110	85	138	20	M16	●	10	50
16-178/60	916178BAZ	16	110	85	178	60	M16	●	10	50





BAZ A4, stainless steel A4



Type	Art-No	d ₀ [mm]	h ₁ ≥ [mm]	h _{ef} ≥ [mm]	L _d [mm]	t _{fix} ≤ [mm]	Thread		 [pcs]	 [pcs]
6-40/2 A4	9X640BAZ	6	35	25	40	2	M6	—	150	750
6-65/15 A4	9X665BAZ	6	45	35	65	15	M6	—	100	500
8-52/2 A4	9X852BAZ	8	45	30	52	2	M8	—	100	500
8-72/10 A4	9X872BAZ	8	60	45	72	10	M8	●	50	250
8-92/30 A4	9X892BAZ	8	60	45	92	30	M8	●	50	250
8-112/50 A4	9X8112BAZ	8	60	45	112	50	M8	●	40	200
10-60/10 A4	9X1060BAZ	10	38	23	60	10	M10	—	50	250
10-92/10 A4	9X1092BAZ	10	75	60	92	10	M10	●	40	200
10-102/20 A4	9X10102BAZ	10	75	60	102	20	M10	●	25	125
10-112/30 A4	9X10112BAZ	10	75	60	112	30	M10	●	25	125
10-132/50 A4	9X10132BAZ	10	75	60	132	50	M10	●	25	125
12-103/5 A4	9X12103BAZ	12	90	70	103	5	M12	●	20	100
12-118/20 A4	9X12118BAZ	12	90	70	118	20	M12	●	20	100
12-128/30 A4	9X12128BAZ	12	90	70	128	30	M12	●	20	100
12-148/50 A4	9X12148BAZ	12	90	70	148	50	M12	●	20	100
12-163/65 A4	9X12163BAZ	12	90	70	163	65	M12	●	20	100
16-123/5 A4	9X16123BAZ	16	110	85	123	5	M16	●	10	50
16-138/20 A4	9X16138BAZ	16	110	85	138	20	M16	●	10	50
16-168/50 A4	9X16168BAZ	16	110	85	168	50	M16	●	10	50





Blister BAZ, zinc plated

Type	Art-No	d_0 [mm]	$h_1 \geq$ [mm]	$h_{ef} \geq$ [mm]	L_d [mm]	$t_{fix} \leq$ [mm]	Thread		 [pcs]	 [Blister]
8-72/10	5874BAZ2	8	60	45	72	10	M8	●	2	10
10-92/10	51095BAZ2	10	75	60	92	10	M10	●	2	10
12-118/20	512115BAZ2	12	90	70	118	20	M12	●	2	10





BAZ HD, hot-dip galvanized

Type	Art-No	d_0 [mm]	$h_1 \geq$ [mm]	$h_{ef} \geq$ [mm]	L_d [mm]	$t_{fix} \leq$ [mm]	Thread		 [pcs]	 [pcs]
6-40/2 HD	9HD640BAZ	6	35	25	40	2	M6	–	150	750
6-65/15 HD	9HD665BAZ	6	45	35	65	15	M6	–	100	500
8-52/2 HD	9HD852BAZ	8	45	30	52	2	M8	–	100	500
8-72/10 HD	9HD872BAZ	8	60	45	72	10	M8	●	50	250
8-92/30 HD	9HD892BAZ	8	60	45	92	30	M8	●	50	250
8-112/50 HD	9HD8112BAZ	8	60	45	112	50	M8	●	40	200
8-147/85 HD	9HD8147BAZ	8	60	45	147	85	M8	●	40	200
10-60/10 HD	9HD1060BAZ	10	38	23	60	10	M10	–	50	250
10-92/10 HD	9HD1092BAZ	10	75	60	92	10	M10	●	40	200
10-102/20 HD	9HD10102BAZ	10	75	60	102	20	M10	●	25	125
10-112/30 HD	9HD10112BAZ	10	75	60	112	30	M10	●	25	125
10-132/50 HD	9HD10132BAZ	10	75	60	132	50	M10	●	25	125
10-162/80 HD	9HD10162BAZ	10	75	60	162	80	M10	●	25	125
12-103/5 HD	9HD12103BAZ	12	90	70	103	5	M12	●	20	100
12-118/20 HD	9HD12118BAZ	12	90	70	118	20	M12	●	20	100
12-128/30 HD	9HD12128BAZ	12	90	70	128	30	M12	●	20	100
12-148/50 HD	9HD12148BAZ	12	90	70	148	50	M12	●	20	100
12-163/65 HD	9HD12163BAZ	12	90	70	163	65	M12	●	20	100
12-178/80 HD	9HD12178BAZ	12	90	70	178	80	M12	●	20	100
16-123/5 HD	9HD16123BAZ	16	110	85	123	5	M16	●	10	50
16-138/20 HD	9HD16138BAZ	16	110	85	138	20	M16	●	10	50
16-168/50 HD	9HD16168BAZ	16	110	85	168	50	M16	●	10	50
16-178/60 HD	9HD16178BAZ	16	110	85	178	60	M16	●	10	50



BAZ HCR, stainless steel, high corrosion resistant

Type	Art-No	d_0 [mm]	$h_1 \geq$ [mm]	$h_{ef} \geq$ [mm]	L_d [mm]	$t_{fix} \leq$ [mm]	Thread		 [pcs]	 [pcs]
8-72/10 HCR	9HCR872BAZ	8	60	45	72	10	M8	●	50	250
10-92/10 HCR	9HCR1092BAZ	10	75	60	92	10	M10	●	40	200
10-112/30 HCR	9HCR10112BAZ	10	75	60	112	30	M10	●	25	125

No stock item; only available on request

Installation parameters

BAZ Size		M6*	M8		M10	M12		M16
BAZ Type			BAZ zinc plated BAZ HD	BAZ A4 BAZ HCR		BAZ zinc plated BAZ HD	BAZ A4 BAZ HCR	
Torque	T_{inst} [Nm]	7	20 / 15**	20	35	50	70	120
Width across flats	SW [mm]	10	13		17	19		24
Ø of clearance hole in fixture	d_f [mm]	7	9		12	14		18
Washer outer Ø x thickness	[mm]	12 x 1,6	17 x 1,6		21 x 2,0	24 x 2,5		30 x 3,0

* Not part of the assessment

** 20 for BAZ, 15 for BAZ HD

Spacing and edge distance

BAZ Size		M8	M10	M12	M16
Effective anchorage depth	h_{ef} [mm]	45	60	70	85
Minimum edge distance	C_{min} [mm]	50	50	55	85
	for $S \geq$ [mm]	50	100	145	150
Minimum spacing	S_{min} [mm]	50	55	60	70
	for $C \geq$ [mm]	50	80	90	120
Characteristic edge distance	C_{cr} [mm]	68	90	105	128
Characteristic spacing	S_{cr} [mm]	135	180	210	255
Min. thickness of structural part	h_{min} [mm]	100	120	140	170

If underrun the char. spacing or edge distance (C_{cr} or S_{cr}) the loads must be reduced. h_{min} , S_{min} and C_{min} must be observed.

Loads

BAZ Size		M8		M10		M12		M16	
BAZ Type		BAZ zinc plated BAZ HD	BAZ A4 BAZ HCR	BAZ zinc plated BAZ HD	BAZ A4 BAZ HCR	BAZ zinc plated BAZ HD	BAZ A4 BAZ HCR	BAZ zinc plated BAZ HD	BAZ A4 BAZ HCR
Permissible tension loads for single anchor without influence of spacing and edge distance ^{1), 2)}									
In cracked concrete C20/25 ³⁾	N_{per} [kN]	2,0	2,0	3,6	3,6	4,8	4,8	9,5	9,5
In non-cracked concrete C20/25 ³⁾	N_{per} [kN]	3,6	3,6	6,3	6,3	7,9	7,9	16,7	16,7
Permissible shear loads for single anchor without influence of spacing and edge distance ^{1), 2)}									
In cracked concrete C20/25	V_{per} [kN]	5,0	5,0	10,3	9,7	13,1	14,3	25,1	25,7
In non-cracked concrete C20/25	V_{per} [kN]	5,7	6,3	10,3	9,7	13,1	14,3	25,1	26,9
Permissible bending moment	M_{per} [Nm]	12,0	12,6	27,4	25,7	41,1	45,1	106,3	114,3

¹⁾ For further information please refer to the ETA assessment

²⁾ Load figures include the resistances' partial safety factors as per ETA assessment and a partial safety factor on the action of $\gamma_F = 1,4$.

Load figures apply for a rebar spacing $S \geq 15$ cm or alternatively for a rebar spacing $S \geq 10$ cm in combination with a rebar diameter of $d_s \leq 10$ mm..

³⁾ For higher concrete strengths up to C50/60 the values increase by max. 31%.

Recommended loads for the not approved anchor sizes M6, M10 in non-cracked concrete C20/25

Type	N_{rec} [kN]	V_{rec} [kN]	Anchorage depth h_{ef} [mm]
BAZ 6-40/2	1,6	2,0	25
BAZ 6-65/15	1,8	2,5	35
BAZ 8-52/2	2,6	4,8	30
BAZ 10-60/10	1,6	2,0	23

N_{rec} : recommended tension load; V_{rec} : recommended shear load

Quick-fix anchor BAZ-H



Advantages



BAZ-H, zinc plated with large washer according to ISO 7094 (DIN 440) for woodworking

Suitable building materials

Very suitable



- Concrete



Approvals and certificates



European Technical Assessment
Option 1 for cracked concrete

see assessment

Mounting

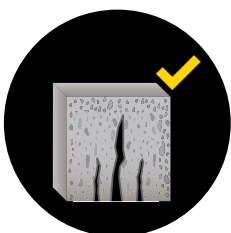
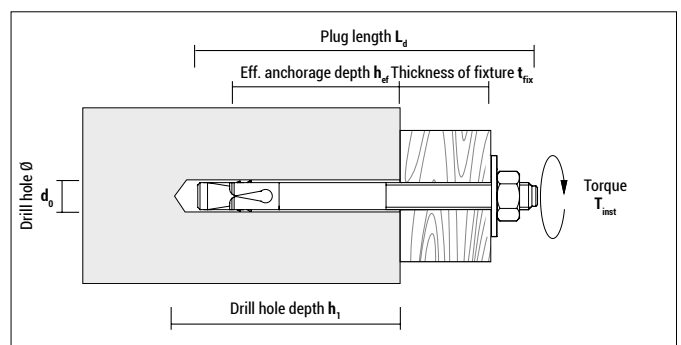
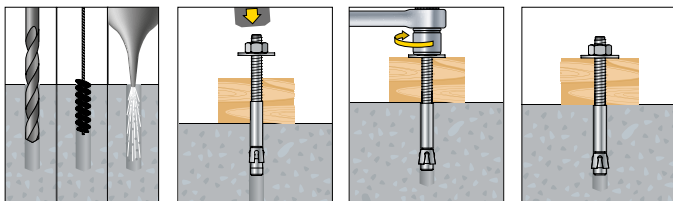

Very good load values
in cracked and non-cracked concrete
(ETA Option 1)

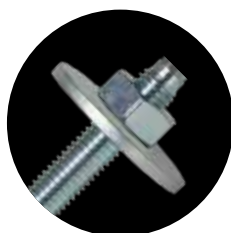

Quick-fix anchor with
large washer according to
ISO 7094 [DIN 440]
for woodworking

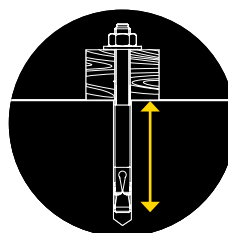

Small setting depth
for quick assembly

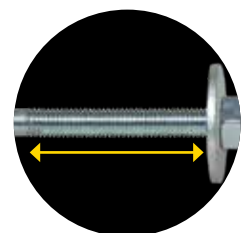

Long thread for high
mounting flexibility



BAZ-H, zinc plated

Type	Art-No	d ₀ [mm]	h ₁ ≥ [mm]	h _{ef} ≥ [mm]	L _d [mm]	t _{nx} ≤ [mm]	Thread	ETA	[pcs]	[pcs]
10-210/140	910210BAZH	10	70	45	210	140	M10	●	20	80
12-203/113	912203BAZH	12	90	62	203	113	M12	●	15	60
12-220/130	912220BAZH	12	90	62	220	130	M12	●	15	60
12-243/153	912243BAZH	12	90	62	243	153	M12	●	15	60
12-258/168	912258BAZH	12	90	62	258	168	M12	●	15	60
12-280/190	912280BAZH	12	90	62	280	190	M12	●	10	40
12-320/230	912320BAZH	12	90	62	320	230	M12	●	10	40
16-220/100	916220BAZH	16	120	88	220	100	M16	●	10	40
16-280/160	916280BAZH	16	120	88	280	160	M16	●	5	20
16-323/203	916323BAZH	16	120	88	323	203	M16	●	5	20
16-370/250	916370BAZH	16	120	88	370	250	M16	●	5	20

Installation parameters

BAZ-H Size		M10	M12	M16
Torque	T _{inst} [Nm]	25	65	110
Width across flats	SW [mm]	17	19	24
Ø of clearance hole in fixture	d _f [mm]	12	14	18
Washer DIN 440 outer Ø x tickness	[mm]	34 x 3	44 x 4	56 x 5

Spacing and edge distance

BAZ-H Size		M10	M12	M16
Effective anchorage depth	h _{ef} [mm]	45	62	88
Minimum edge distance	C _{min} [mm]	70	85	70
Minimum spacing	S _{min} [mm]	60	70	60
Characteristic edge distance	C _{cr} [mm]	68	93	132
Characteristic spacing	S _{cr} [mm]	135	186	264
Min. thickness of structural part	h _{min} [mm]	120	140	160

If underrun the char. spacing or edge distance (C_{cr} or S_{cr}) the loads must be reduced. h_{min}, S_{min} and C_{min} must be observed.

Loads

BAZ-H Size		M10	M12	M16
Zulässige zentrische Zuglast^{1), 2)} for single anchor without influence of spacing and edge distance in cracked concrete C20/25³⁾				
BAZ-H zinc plated	N _{zul} [kN]	2,9	3,8	8,6
Zulässige zentrische Zuglast^{1), 2)} for single anchor without influence of spacing and edge distance in non-cracked concrete C20/25³⁾				
BAZ-H zinc plated	N _{zul} [kN]	5,2	8,6	11,9
Zulässige Querlast^{1), 2)} for single anchor without influence of spacing and edge distance in cracked concrete C20/25³⁾				
BAZ-H zinc plated	V _{zul} [kN]	5,0	16,0	27,1
Zulässige Querlast^{1), 2)} for single anchor without influence of spacing and edge distance in non-cracked concrete C20/25³⁾				
BAZ-H zinc plated	V _{zul} [kN]	7,1	21,4	32,4
Permissible bending moment^{1), 2)}				
BAZ-H zinc plated	M _{zul} [Nm]	24,3	43,8	95,2

¹⁾ For further information please refer to the ETA assessment

²⁾ Load figures include the resistances' partial safety factors as per ETA assessment and a partial safety factor on the action of γ_r = 1,4.

Load figures apply for a rebar spacing S ≥ 15 cm or alternatively for a rebar spacing S ≥ 10 cm in combination with a rebar diameter of ds ≤ 10 mm.

³⁾ For higher concrete strengths up to C50/60 the values increase by max. 58%.

Quick-fix anchor BA plus



Advantages



BA plus, zinc plated



BA plus, zinc plated with large washer according to ISO 7094 (DIN 440) for woodworking

Suitable building materials

Very suitable



- Non-cracked concrete 

Suitable to a limited extent

- Dense natural stone (up to M8)

Approvals and certificates



European Technical Assessment
Option 7 for non-cracked concrete

Mounting

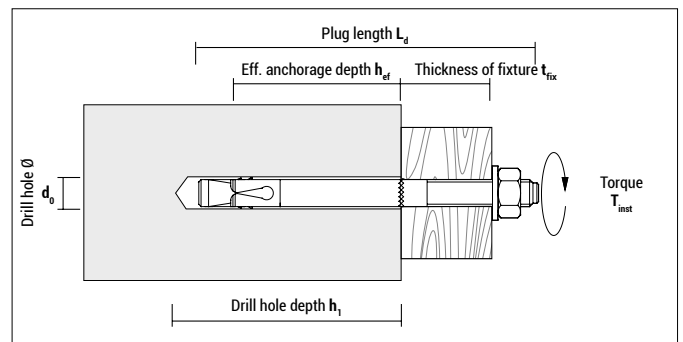
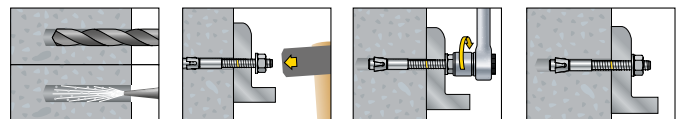

Excellent load values
in non-cracked concrete



Wide **range for wood-
working with large
washer** according to
ISO 7094 [DIN 440]



**Setting depth
marking ring** for
quick installation

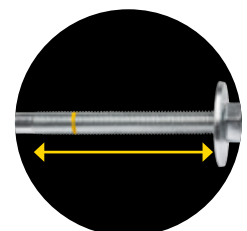

Long thread
for higher mounting
flexibility



BA plus, zinc plated

Type	Art-No	d ₀ [mm]	h ₁ ≥ [mm]	h _{ef} ≥ [mm]	L _d [mm]	t _{fix} ≤ [mm]	Thread		 [pcs]	 [pcs]
6-45/5	9645BAP	6	38	25	45	5	M6	–	100	500
6-60/10	9660BAP	6	48	35	60	10	M6	●	100	500
6-80/30	9680BAP	6	48	35	80	30	M6	●	100	500
6-100/50	96100BAP	6	48	35	100	50	M6	●	100	500
8-50/5	9850BAP	8	40	25	50	5	M8	–	100	500
8-60/10	9860BAP	8	45	30	60	10	M8	–	50	250
8-75/10	9875BAP	8	60	45	75	10	M8	●	50	250
8-85/20	9885BAP	8	60	45	85	20	M8	●	50	250
8-95/30	9895BAP	8	60	45	95	30	M8	●	50	250
8-115/50	98115BAP	8	60	45	115	50	M8	●	40	200
8-135/70	98135BAP	8	60	45	135	70	M8	●	40	200
10-60/10	91060BAP	10	42	27	60	10	M10	–	50	250
10-75/10	91075BAP	10	55	40	75	10	M10	–	50	250
10-85/10	91085BAP	10	65	50	85	10	M10	●	40	200
10-92/17	91092BAP	10	65	50	92	17	M10	●	40	200
10-105/30	910105BAP	10	65	50	105	30	M10	●	25	125
10-125/50	910125BAP	10	65	50	125	50	M10	●	25	125
10-145/70	910145BAP	10	65	50	145	70	M10	●	25	125
10-175/100	910175BAP	10	65	50	175	100	M10	●	25	125
12-70/2	91270BAP	12	58	38	70	2	M12	–	40	200
12-110/10	912110BAP	12	90	70	110	10	M12	●	20	100
12-120/20	912120BAP	12	90	70	120	20	M12	●	20	100
12-130/30	912130BAP	12	90	70	130	30	M12	●	20	100
12-150/50	912150BAP	12	90	70	150	50	M12	●	20	100
12-180/80	912180BAP	12	90	70	180	80	M12	●	20	100
16-95/10	91695BAP	16	75	50	95	10	M16	–	15	75
16-135/15	916135BAP	16	110	85	135	15	M16	●	10	50
16-150/30	916150BAP	16	110	85	150	30	M16	●	10	50
16-180/60	916180BAP	16	110	85	180	60	M16	●	10	50
16-200/80	916200BAP	16	110	85	200	80	M16	●	10	50
20-110/10	920110BAP	20	90	60	110	10	M20	–	10	40
20-160/20	920160BAP	20	130	100	160	20	M20	●	10	40
20-215/75	920215BAP	20	130	100	215	75	M20	●	6	24
20-270/130	920270BAP	20	130	100	270	130	M20	●	5	20









BA plus with large washer according to ISO 7094 (DIN 440) for woodworking, zinc plated

Type	Art-No	d ₀ [mm]	h ₁ ≥ [mm]	h _{ef} ≥ [mm]	L _d [mm]	t _{fix} ≤ [mm]	Thread		 [pcs]	 [pcs]
10-215/140	910215BAP	10	65	50	215	140	M10	●	25	100
12-200/100	912200BAP	12	90	70	200	100	M12	●	20	80
12-220/120	912220BAP	12	90	70	220	120	M12	●	20	80
12-240/140	912240BAP	12	90	70	240	140	M12	●	20	80
12-260/160	912260BAP	12	90	70	260	160	M12	●	20	80
12-300/200	912300BAP	12	90	70	300	200	M12	●	15	60
12-320/220	912320BAP	12	90	70	320	220	M12	●	15	60
16-220/100	916220BAP	16	110	85	220	100	M16	●	10	40
16-270/150	916270BAP	16	110	85	270	150	M16	●	10	40
16-320/200	916320BAP	16	110	85	320	200	M16	●	10	40



Blister BA plus, zinc plated

Type	Art-No	d_0 [mm]	$h_1 \geq$ [mm]	$h_{ef} \geq$ [mm]	L_d [mm]	$t_{fix} \leq$ [mm]	Thread		 [pcs]	 [Blister]
8-85/20	5885BA2	8	60	45	85	20	M8		2	10
10-92/17	51090BA2	10	65	50	92	17	M10		2	10
10-125/50	510120BA2	10	65	50	125	50	M10		2	10

Installation parameters

BA plus Size		M6	M8	M10	M12	M16	M20
Torque	T_{inst} [Nm]	8	15	30	50	110	180
Width across flats	SW [mm]	10	13	17	19	24	30
Ø of clearance hole in fixture	d_f [mm]	7	9	12	14	18	22
Washer outer Ø x thickness	[mm]	12 x 1,6	16 x 1,6	20 x 2 / 34 x 3	24 x 2,5 / 44 x 4	30 x 3 / 56 x 5	37 x 3

Loads, spacing and edge distance BA plus approved sizes M6 - M20

Type	Permissible loads in concrete ¹⁾²⁾³⁾		Permissible bending moment M_{per} [Nm]	Spacing ⁴⁾		Edge distance ⁴⁾		Min. thickness of structural part h_{min} [mm]
	C 20/25 Tension N_{per} [kN]	C 20/25 Shear V_{per} [kN]		S_{cr} [mm]	S_{min} [mm]	C_{cr} [mm]	C_{min} [mm]	
BA plus 6	3,6	3,0	4,7	105	50	53	50	100
BA plus 8	7,3	6,5	13,4	135	50	68	50	100
BA plus 10	7,6	8,5	23,9	150	120	75	90	120
BA plus 12	11,4	9,5	46,8	210	70	105	90	160
BA plus 16	12,7	14,6	95,1	255	100	128	100	200
BA plus 20	19,8	24,0	127,3	300	160	150	150	200

¹⁾ Permissible loads for single anchor without influence of spacing and edge distance.

²⁾ Load figures include the resistances' partial safety factors as per ETA assessment and a partial safety factor on the action of $v_F = 1,4$.

³⁾ For higher concrete strengths up to C50/60 the values increase by max. 55%.

⁴⁾ If underrun the char. spacing or edge distance (C_{cr} or S_{cr}) the loads must be reduced. h_{min} , S_{min} and C_{min} must be observed.

Recommended loads for the not approved anchor sizes in non-cracked concrete C20/25

Type	N_{rec} [kN]	V_{rec} [kN]	Eff. anchorage depth h_{ef} [mm]
BA plus 6-45/5	1,5	1,5	25
BA plus 8-50/5	1,5	1,5	25
BA plus 8-60/10	2,5	2,5	30
BA plus 10-60/10	1,8	1,8	27
BA plus 10-75/10	2,5	2,5	40
BA plus 12-70/2	2,4	2,4	38
BA plus 16-95/10	4,0	4,0	50
BA plus 20-110/10	6,0	6,0	60

N_{rec} : recommended tension load; V_{rec} : recommended shear load

Quick-fix anchor BA A4



Advantages



BA A4, stainless steel A4

Suitable building materials

Very suitable



- Non-cracked concrete 

Suitable to a limited extent

- Dense natural stone (up to M8)

Approvals and certificates

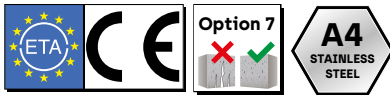

European Technical Assessment
Option 7 for non-cracked concrete

Mounting

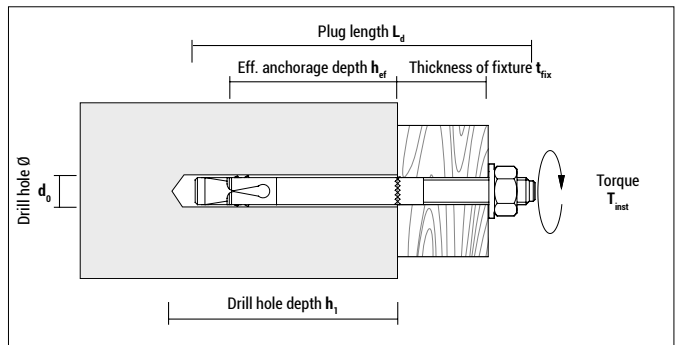
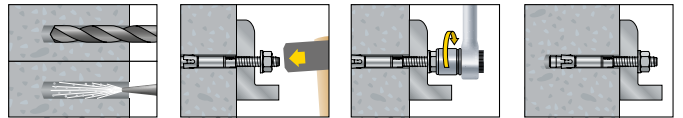

Quick-fix anchor made of stainless steel A4
for fast installation in non-cracked concrete





Suitable for a wide range of approval relevant applications
for outdoor usage, facade substructures aso.



High load values and small edge and axial distances
usable even in tough installation situations



BA A4, stainless steel A4

Type	Art-No	d ₀ [mm]	h ₁ ≥ [mm]	h _{ef} ≥ [mm]	L _d [mm]	t _{fix} ≤ [mm]	Thread		 [pcs]	 [pcs]
8-72/10 A4	9X872BA	8	60	45	72	10	M8	●	50	250
8-92/30 A4	9X892BA	8	60	45	92	30	M8	●	50	250
8-112/50 A4	9X8112BA	8	60	45	112	50	M8	●	40	200
10-92/10 A4	9X1092BA	10	75	60	92	10	M10	●	40	200
10-102/20 A4	9X10102BA	10	75	60	102	20	M10	●	25	125
10-112/30 A4	9X10112BA	10	75	60	112	30	M10	●	25	125
10-132/50 A4	9X10132BA	10	75	60	132	50	M10	●	25	125
12-103/5 A4	9X12103BA	12	90	70	103	5	M12	●	20	100
12-118/20 A4	9X12118BA	12	90	70	118	20	M12	●	20	100
12-128/30 A4	9X12128BA	12	90	70	128	30	M12	●	20	100
12-148/50 A4	9X12148BA	12	90	70	148	50	M12	●	20	100
12-163/65 A4	9X12163BA	12	90	70	163	65	M12	●	20	100
16-123/5 A4	9X16123BA	16	110	85	123	5	M16	●	10	50
16-138/20 A4	9X16138BA	16	110	85	138	20	M16	●	10	50
16-168/50 A4	9X16168BA	16	110	85	168	50	M16	●	10	50

Installation parameters

BA Size		M8	M10	M12	M16
Torque	T _{inst} [Nm]	20	35	70	120
Width across flats	SW [mm]	13	17	19	24
Ø of clearance hole in fixture	d _r [mm]	9	12	14	18
Washer outer Ø x thickness	[mm]	17 x 1,6	21 x 2,0	24 x 2,5	30 x 3,0

Loads, spacing and edge distance BA A4 approved sizes M8 - M16

Type	Permissible loads in concrete ¹⁾²⁾³⁾		Permissible bending moment M _{per} [Nm]	Spacing ⁴⁾		Edge distance ⁴⁾		Min. thickness of structural part h _{min} [mm]
	C 20/25 Tension N _{per} [kN]	C 20/25 Shear V _{per} [kN]		S _{min} [mm]	S _{cr} [mm]	C _{min} [mm]	C _{cr} [mm]	
BA A4 8	3,6	6,3	12,6	50	135	50	68	100
BA A4 10	6,3	9,7	25,7	55	180	50	90	120
BA A4 12	7,9	14,3	45,1	60	210	55	105	140
BA A4 16	16,7	26,9	114,3	70	255	85	128	170

¹⁾ Permissible loads for single anchor without influence of spacing and edge distance.

²⁾ Load figures include the resistances' partial safety factors as per ETA assessment and a partial safety factor on the action of $\gamma_F = 1,4$.

³⁾ For higher concrete strengths up to C50/60 the values increase by max. 28%.

⁴⁾ If underrun the char. spacing or edge distance (C_{cr} or S_{cr}) the loads must be reduced. h_{min}, S_{min} and C_{min} must be observed.



CELO Befestigungssysteme GmbH
Industriestraße 6
D-86551 Aichach
www.celofixings.com
Hotline: +49 (0) 8251-90485-0
Telefax: +49 (0) 8251-90485-49
E-mail: info@celofixings.de

Small Things Matter

Presented by:

EN 04/21

Technical products and illustrations are subject to change. The reprint of this brochure, in part or in whole, is prohibited.
CELO Befestigungssysteme GmbH accepts no liability for the correctness of the information provided.